

FO3 FC Series

Outdoor Common

Cathode Full Color Aluminum Screen

Specification



KMTEKLED PHOTOELECTRICITY CO.LTD

Vision: Make the LED display more colorful, more intelligent, To be the leading brand in led screen industry.

Catalogue

Chapter 1 Product Introduction	2
Chapter 2 Structural Appearance	3
2.1 Module Pictures	3
2.2 Cabinet Pictures	3
2.3 Technical Parameters	4
2.4 Packing List	8
2.5 Power Supply Configuration Project	8
2.6 Accessories	8
Chapter 3 Interface Definition	9
3.1 Interface Picture (HUB75)	9
3.2 Interface Definition	9
Chapter 4 Installation	10
4.1 Kit Installation	10
4.2 Cabinet Installation	10
4.3 Cabinet structure	11
4.4 Display Installation	12
4.5 Networking Introduction	12
4.6 Installation Method	13
Chapter 5 Description for Product Features	14
5.1 New added vent valve	14
5.2 Strong Adaptability for outdoor environmental condition	14
5.3 Structural Hard Link, Wireless Design	15
5.4 Aluminum Profile Cabinet, Lightweight, Safety and Reliability, No Distortion	16
Chapter 6 User Manual	17
6.1 Notification	17
6.2 User Manual	17
6.3 Acceptance Request and Method	18
Chapter 7 Application Field	19

Chapter 1 Product Introduction

- **Common Cathode with Energy-Saving**

Common cathode is an energy-saving power supply technology for LED display, which can effectively solve the problems of high screen temperature and excessive power consumption of common anode circuit. the average temperature of the panel of the common cathode circuit is 15°C lower than that of the traditional common anode circuit, and the power consumption is reduced by more than 20%.

- **Real color, more realistic picture**

The refresh rate is up to 3840Hz, the high contrast ratio, the grayscale is above 16 bit, the picture is vivid and delicate, the brightness is stable and even, not dazzling or grainy. Red, green and blue three-in-one LED lamp beads, with good consistency, and the viewing angle can reach more than 140°.

- **Structure optimization, flexible installation**

It supports various installation methods such as floor-standing, hoisting, and wall-mounted. Modular design of module, cabinet and power cabinet, front and rear maintenance, hard connection, no structural installation, saving structural cost.

- **Driving Project**

Self-designed electronic circuit engineering board, double row tube, 32 capacitors, It has the function of list up and down hidden, high refreshing ratio, dark dot amended in first line, low grayscale amended, color cast and spot amended, etc.

- **Stable and high protection**

Outdoor application products, IP66 protection grade, integrated all-aluminum design, with corrosion resistance, high melting point, flame retardant and fire resistance, moisture resistance and salt spray resistance, working temperature -40 °C -80 °C, can operate normally in the seaside environment for a long time, The ability to adapt to the environment is very strong, and it can work outdoors all day long.

- **Stable and reliable performance**

Ultra-low temperature rise, low power consumption, low attenuation, and the good thermal conductivity of the aluminum module itself, make the heat dissipation effect of the whole screen better, no need to install air conditioners, high reliability and long service life.

Chapter 2 Structural Appearance

2.1 Module Pictures

(FO3 FC Series)

Picture 2-1 Die-cast aluminium modules(480*320*15.7mm)

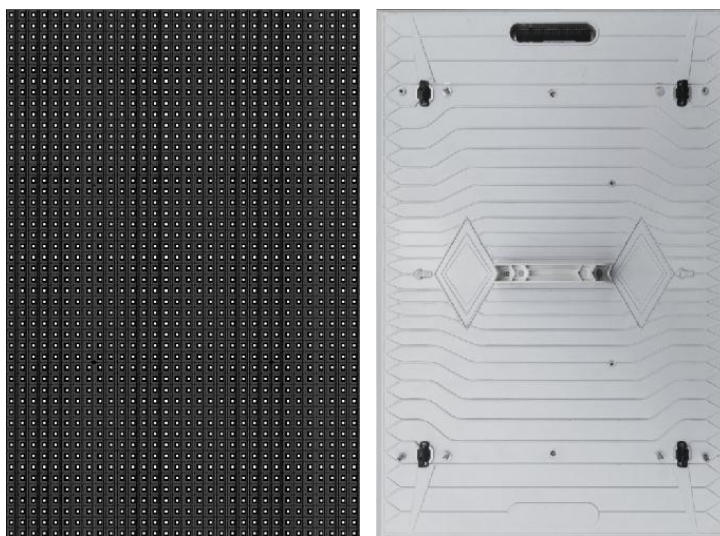

2.2 Cabinet Pictures

Picture 2-2 Profile cabinet(960*960*92mm)

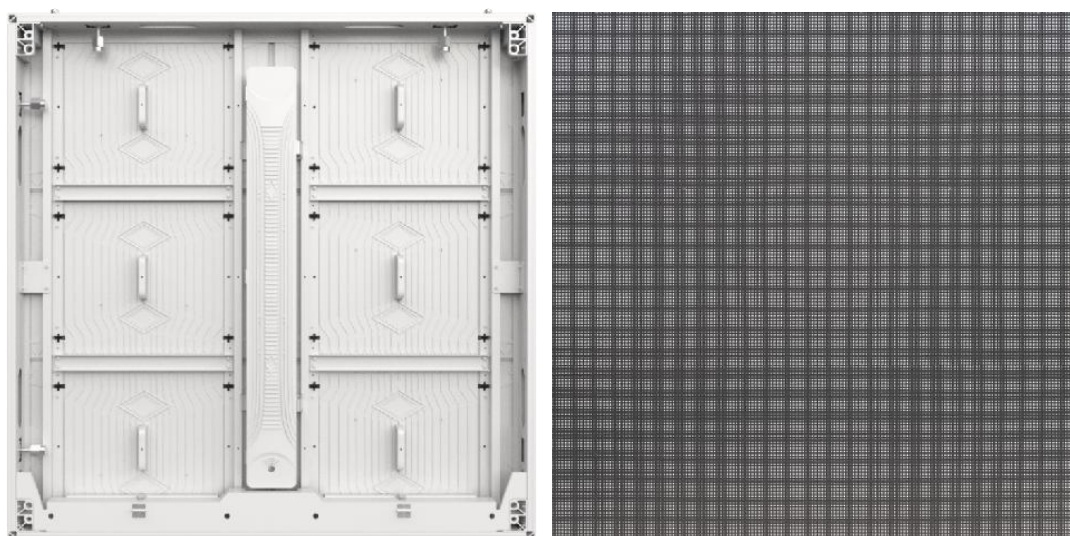

2.3 Technical Parameters

Table 2-1 Technical Parameters (Common Cathode)

Item	FC3.33	FC4.44	FC5.7	FC6.67	FC8	FC10
Pixel Composition(SMD)	1415	1921	2727	2727	2727	2727
Pixel Pitch(mm)	3.33	4.44	5.7	6.67	8	10
Module Resolution(W×H)	144×96	108×72	84×56	72×48	60×40	48×32
Module Size(mm)	480×320×16					
Module Weight(kg)	2					
Module Qty/Cabinet(W×H)	2×3					
Cabinet Resolution(W×H)	288×288	216×216	168×168	144×144	120×120	96×96
Cabinet Size(mm)	960×960×87					
Cabinet Area(m ²)	0.92					
Cabinet Weight(kg/cabinet)	24.5					
Cabinet Material	Profile cabinet					
Cabinet Density (dot/m ²)	90000	50625	30625	22500	15625	10000
IP Rating	IP66					
White Balance Brightness(nits)	≥4500	≥5000	≥5000	≥5500	≥5500	≥6000
Color Processor(bit)	16					
Color Temperature(K)	6500-9000					
Visual Angle(H/V)	140°/ 120°					
Luminous point centre deviation	<3%					
Luminance uniformity	≥97%					
Chromaticity uniformity	Within ±0.003Cx, Cy					
Contrast Ratio	≥15000:1					
The Max Power Consumption(W/m ²)	550	550	550	550	550	550
Average Power Consumption(W/m ²)	186	186	186	186	186	186
Input Voltage	AC100~240V					
Frequency(Hz)	50&60					
IC Driving(s)	1/12	1/9	1/7	1/6	1/3	1/2
Refreshing Ratio(Hz)	3840					
Maintenance Method	Front and Rear					
Lifespan(hrs)	100,000					
Work Temperature/Humidity	-40℃-80℃/10%RH-98%RH (Non Condensing)					
Storage Temperature/Humidity	-20℃-60℃/10%RH-98%RH (Non Condensing)					

*Note: Maximum power consumption fluctuates by 10% depending on the batch of LED chips, and specifications are subject to change without notice.

Table 2-2 Technical Parameters (Common Anode)

Item	FC3.33	FC4.44	FC5.7	FC6.67	FC8	FC10
Pixel Composition(SMD)	1415	1921	2727	2727	2727	2727
Pixel Pitch(mm)	3.33	4.44	5.7	6.67	8	10
Module Resolution(W×H)	144×96	108×72	84×56	72×48	60×40	48×32
Module Size(mm)	480×320×16					
Module Weight(kg)	2					
Module Qty/Cabinet(W×H)	2×3					
Cabinet Resolution(W×H)	288×288	216×216	168×168	144×144	120×120	96×96
Cabinet Size(mm)	960×960×87					
Cabinet Area(m ²)	0.92					
Cabinet Weight(kg/cabinet)	24.5					
Cabinet Material	Profile cabinet					
Cabinet Density (dot/m ²)	90000	50625	30625	22500	15625	10000
IP Rating	IP66					
White Balance Brightness(nits)	≥4500	≥5000	≥5000	≥5500	≥5500	≥6000
Color Processor(bit)	16					
Color Temperature(K)	6500-9000					
Visual Angle(H/V)	140°/ 120°					
Luminous point centre deviation	<3%					
Luminance uniformity	≥97%					
Chromaticity uniformity	Within ±0.003Cx, Cy					
Contrast Ratio	≥15000:1					
The Max Power Consumption(W/m ²)	700	700	700	700	700	800
Average Power Consumption(W/m ²)	235	235	235	235	235	268
Input Voltage	AC100~240V					
Frequency(Hz)	50&60					
IC Driving(s)	1/12	1/9	1/7	1/6	1/3	1/2
Refreshing Ratio(Hz)	3840					
Maintenance Method	Front and Rear					
Lifespan(hrs)	100,000					
Work Temperature/Humidity	-40℃-80℃/10%RH-98%RH (Non Condensing)					
Storage Temperature/Humidity	-20℃-60℃/10%RH-98%RH (Non Condensing)					

*Note: Maximum power consumption fluctuates by 10% depending on the batch of LED chips, and specifications are subject to change without notice.

Table 2-3 Technical Parameters (Ultra-energy saving)

Item	FC5.7	FC6.67	FC8	FC10
Pixel Composition(SMD)	2727	2727	2727	2727
Pixel Pitch(mm)	5.7	6.67	8	10
Module Resolution(W×H)	84×56	72×48	60×40	48×32
Module Size(mm)	480×320×16			
Module Weight(kg)	2			
Module Qty/Cabinet(W×H)	2×3			
Cabinet Resolution(W×H)	168×168	144×144	120×120	96×96
Cabinet Size(mm)	960×960×92			
Cabinet Area(m ²)	0.92			
Cabinet Weight(kg/cabinet)	24.5			
Cabinet Material	Profile cabinet			
Cabinet Density (dot/m ²)	30625	22500	15625	10000
IP Rating	IP66			
White Balance Brightness(nits)	6000	6000	6000	7000
Color Processor(bit)	16			
Color Temperature(K)	6500-9000			
Visual Angle(H/V)	140°/ 120°			
Luminous point centre deviation	<3%			
Luminance uniformity	≥97%			
Chromaticity uniformity	Within ±0.003Cx, Cy			
Contrast Ratio	≥15000:1			
The Max Power Consumption(W/m ²)	280	280	280	280
Average Power Consumption(W/m ²)	76	76	76	76
Input Voltage	AC100~240V			
Frequency(Hz)	50&60			
IC Driving(s)	1/7	1/6	1/3	1/2
Refreshing Ratio(Hz)	3840			
Maintenance Method	Front and Rear			
Lifespan(hrs)	100,000			
Work Temperature/Humidity	-40℃-80℃/10%RH-98%RH (Non Condensing)			
Storage Temperature/Humidity	-20℃-60℃/10%RH-98%RH (Non Condensing)			

*Note: Maximum power consumption fluctuates by 10% depending on the batch of LED chips, and specifications are subject to change without notice.

Table 2-4 Technical Parameters (Super Brightness)

Item	FC5.7	FC6.67	FC8	FC10
Pixel Composition(SMD)	2727	2727	2727	2727
Pixel Pitch(mm)	5.7	6.67	8	10
Module Resolution(W×H)	84×56	72×48	60×40	48×32
Module Size(mm)	480×320×16			
Module Weight(kg)	2			
Module Qty/Cabinet(W×H)	2×3			
Cabinet Resolution(W×H)	168×168	144×144	120×120	96×96
Cabinet Size(mm)	960×960×92			
Cabinet Area(m ²)	0.92			
Cabinet Weight(kg/cabinet)	24.5			
Cabinet Material	Profile cabinet			
Cabinet Density (dot/m ²)	30625	22500	15625	10000
IP Rating	IP66			
White Balance Brightness(nits)	12000	12000	12000	12000
Color Processor(bit)	16			
Color Temperature(K)	6500-9000			
Visual Angle(H/V)	140°/ 120°			
Luminous point centre deviation	<3%			
Luminance uniformity	≥97%			
Chromaticity uniformity	Within ±0.003Cx, Cy			
Contrast Ratio	≥15000:1			
The Max Power Consumption(W/m ²)	450	450	450	500
Average Power Consumption(W/m ²)	150	150	150	168
Input Voltage	AC100~240V			
Frequency(Hz)	50&60			
IC Driving(s)	1/7	1/6	1/3	1/2
Refreshing Ratio(Hz)	3840			
Maintenance Method	Front and Rear			
Lifespan(hrs)	100,000			
Work Temperature/Humidity	-40℃-80℃/10%RH-98%RH (Non Condensing)			
Storage Temperature/Humidity	-20℃-60℃/10%RH-98%RH (Non Condensing)			

*Note: Maximum power consumption fluctuates by 10% depending on the batch of LED chips, and specifications are subject to change without notice.

2.4 Packing List

Table 2-5 Packing List

Packing List	Quantity	Unit
LED Display	1	Set
User Manual	1	pcs
Approved Certificate	1	pcs
Warranty Card	1	pcs
Construction Notification	1	pcs







2.5 Power Supply Configuration Project

Table 2-6 Supply Configuration Project

Power Supply	Configuration Project
300/400W Power Supply	Can load 4pcs modules

2.6 Accessories

Table 2-7 Accessories List

Accessories		
		
Power Supply	Single Cable	Screws, Sleeve Piece
		
equipment for front and rear maintenance	connecting sheet	connecting sheet

Chapter 3 Interface Definition

3.1 Interface Picture (HUB75)

Picture 3-1 Interface Picture (HUB75)

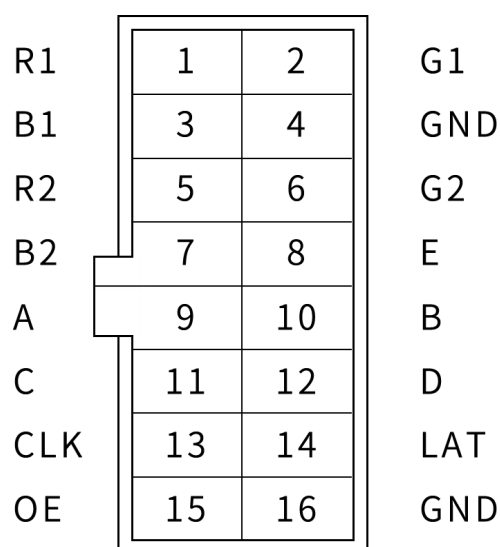

3.2 Interface Definition

Table 3-1 Interface Definition

Pin	Signal	Function	Pin	Signal	Function
1	R1	Red Data Signal	2	G1	Green Data Signal
3	B1	Blue Data Signal	4	GND	Power Ground
5	R2	Red Data Signal	6	G2	Green Data Signal
7	B2	Blue Data Signal	8	E	Row Decoding Signal
9	A	Row Decoding Signal	10	B	Row Decoding Signal
11	C	Row Decoding Signal	12	D	Row Decoding Signal
13	CLK	Clock Signal	14	LAT	Latch Signal
15	OE	Enable Signal	16	GND	Power Ground

Chapter 4 Installation

4.1 Kit Installation

Picture 4-1 Hole Installation Diagram for Kit

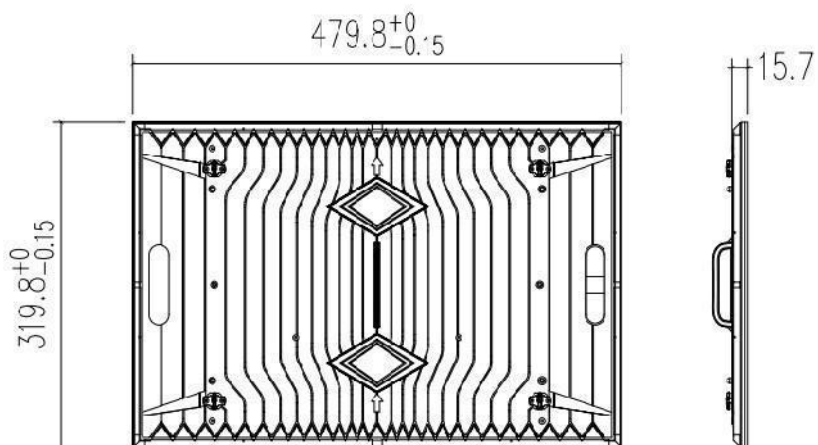

4.2 Cabinet Installation

Picture 4-2 Hole Installation Diagram for Kit

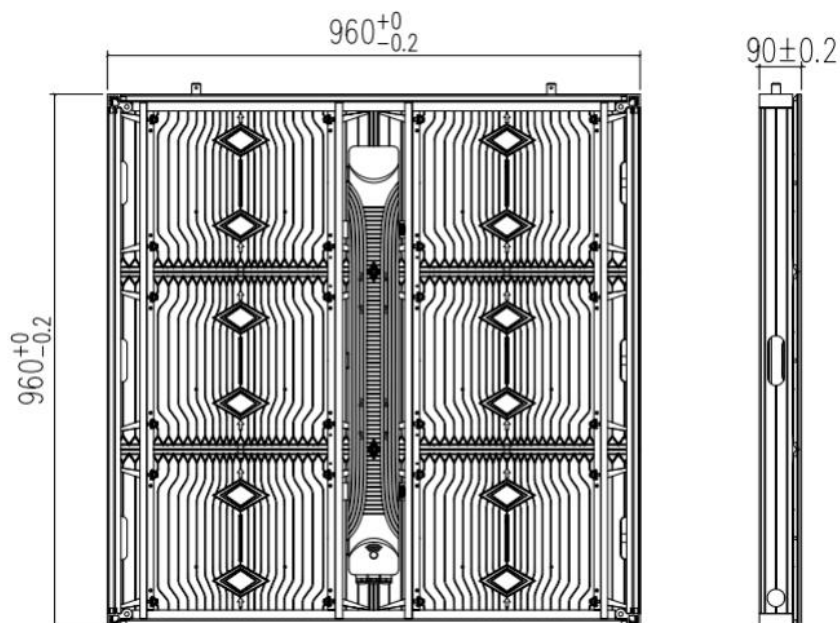

4.3 Cabinet structure

Picture 4-3 Cabinet structure

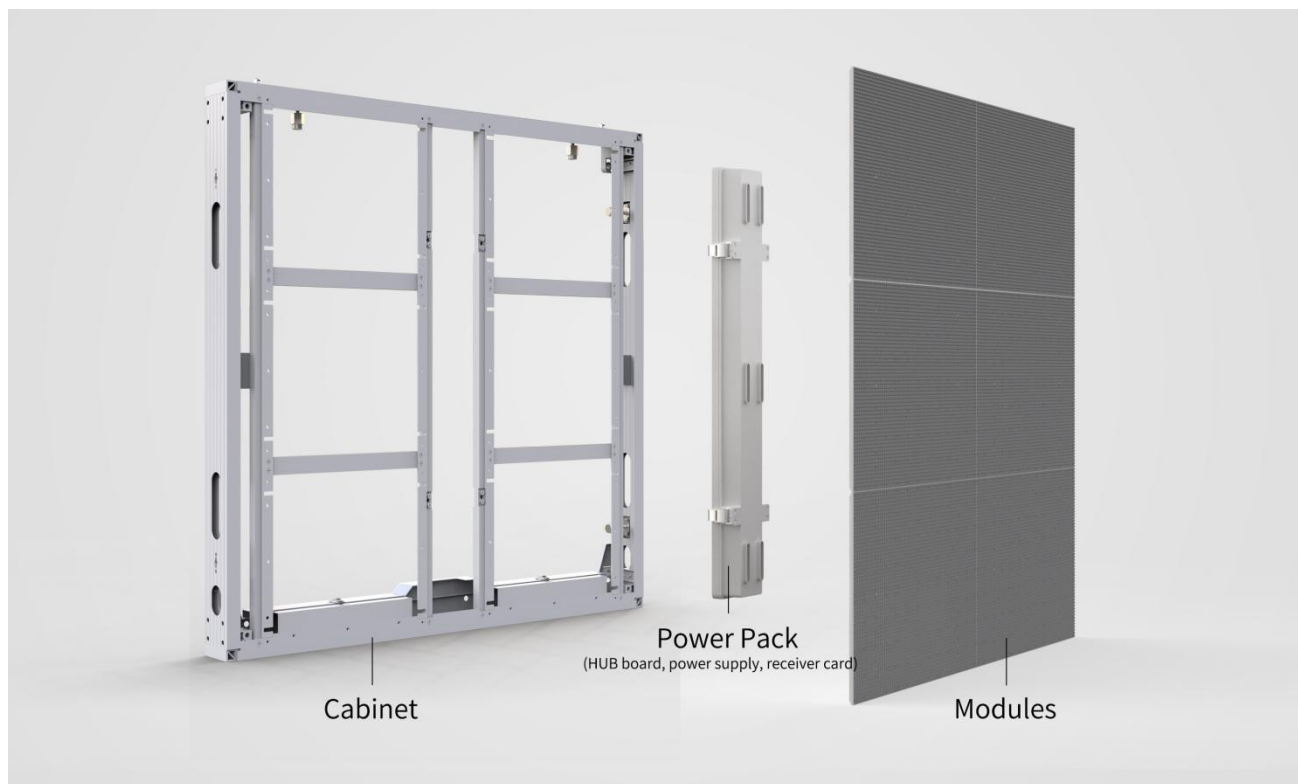

Picture 4-4 After finishing to install for cabinet

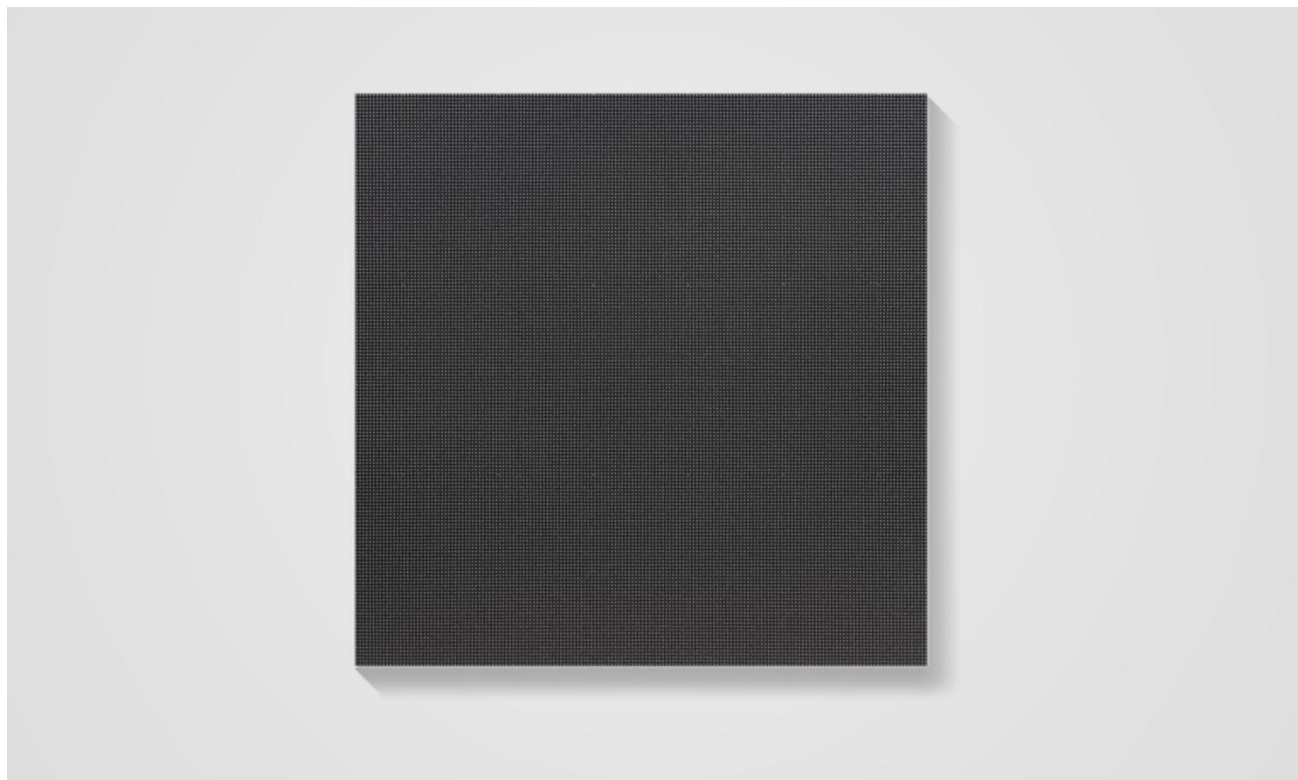

4.4 Display Installation

Picture 4-5 Diagram for Connection

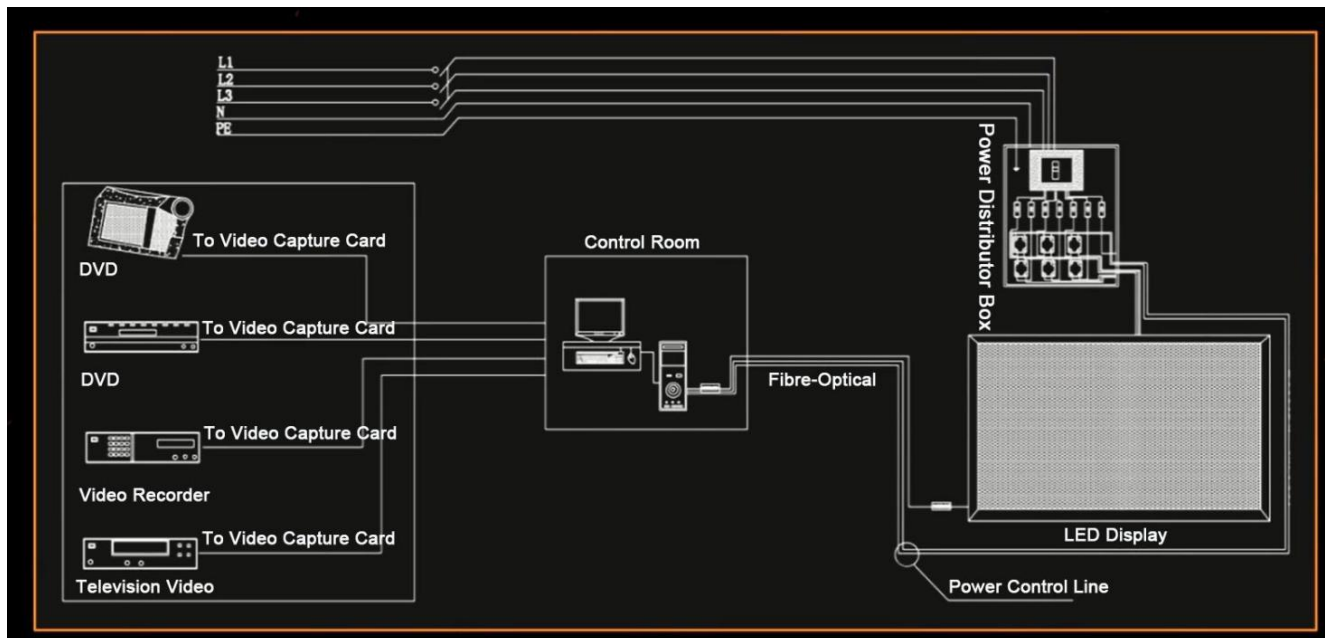

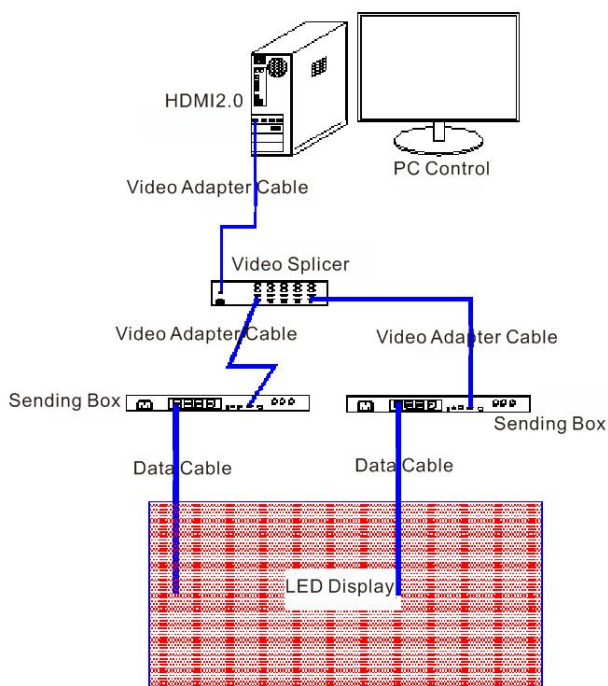

4.5 Networking Introduction

Picture 4-6 Topographic Picture for networking

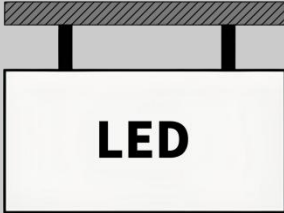
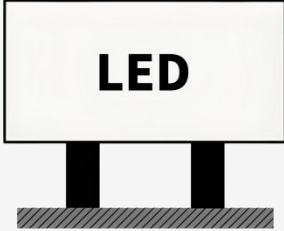

4.6 Installation Method

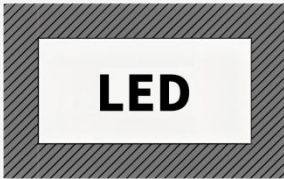
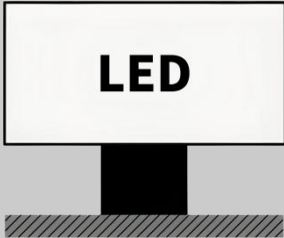
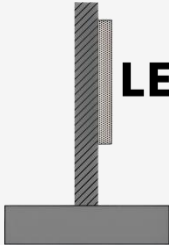
Installation Type	Picture
Hanging Style	
Supporting Style	
Landing Style	
Inlaying Style	
Struting Style	
Wall-attaching Style	

Chapter 5 Description for Product Features

5.1 New added vent valve

For the FC series of LED display, a vent valve has added in the bottom of power cabinet, it can adjust inner gas pressure, recoil temperature rise and balance inner environment.

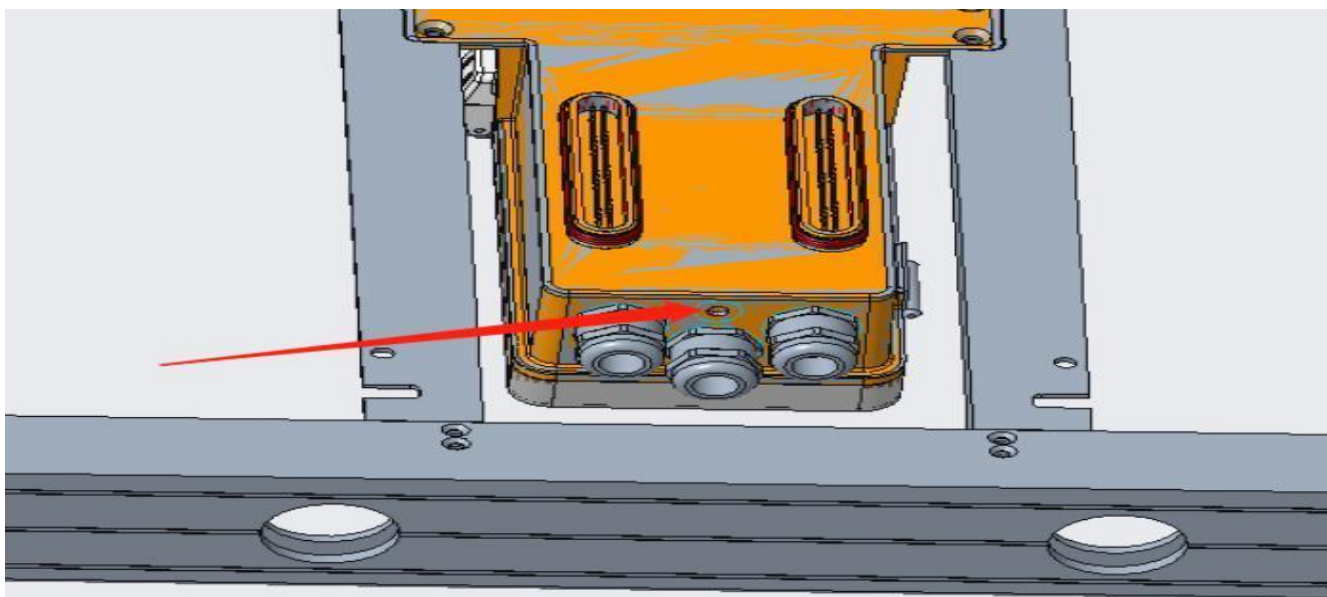

5.2 Strong Adaptability for outdoor environmental condition





5.3 Structural Hard Link, Wireless Design.

The product structure is to adopt hard link, wireless design, its appearance is tidy and beautiful.



5.4 Aluminum Profile Cabinet, Lightweight, Safety and Reliability, No Distortion.

FC series of LED display is to adopt aluminum profile cabinet, the weight of single cabinet is just 24.5KG, display module is die-casting aluminum material, it is fire resistance, no distortion even it is under the high environmental temperature.



Chapter 6 User Manual

6.1 Notification

Table 6-1 Notification

Item	Notification
Temperature	Keep the work temperature within $-10^{\circ}\text{C} \sim 50^{\circ}\text{C}$
Humidity	Keep the storage temperature within $-20^{\circ}\text{C} \sim 60^{\circ}\text{C}$
Waterproof	Keep the work humidity within $10\%RH \sim 98\%RH$
Dust-proof	Keep the storage humidity within $10\%RH \sim 98\%RH$
Anti-Electromagnetic radiation	IP66
Electrostatic Prevention	IP66
Temperature	LED display shouldn't put under the environment where has strong interference by electromagnetic radiation, which would be easy to picture display abnormal.
Humidity	It should be ground connected well for power supply, cabinet, mental cover of display body, the resistance of ground connection $< 10\Omega$, to avoid making any damage to electric components.

6.2 User Manual

Table 6-2 User Manual

Item	User Manual
Electrostatic Protection	The installer need wear electrostatic ring and electric gloves, each equipment should take ground connection well when installing.
Connection Type	There are positive and negative electrode silk printed on module, don't allow to reverse connect, and prohibit to connect with AC 220V.
Operate Type	Prohibit to assemble module, cabinet and whole of display under power on, operation should be under power off completely, to protect personal safety; Prohibit anyone to touch when the LED display is working, in case the static electricity which is generated by body to break through LED and other components.
Dismantle and Transportation	Don't allow to throw, push, compress module, to prevent module falling down, to avoid breaking kit, damage LED chips, etc.

Item	User Manual
Environmental Inspection	It should match temperature and humidity meter for LED display at installation site, to monitor its surrounding environment, so that it can find out if LED display being affected with damp, moisture, etc.
The Usage of LED display	<p>1.The environmental humidity should be 10%RH~65%RH, it is suggested to turn on LED display one time each day, normal to use above 4 hours each time, to remove its damp.</p> <p>2.When the environmental humidity is above 65%RH, it should make dehumidification to environment, and it is suggested to work LED display above 8h each day.</p> <p>3.When LED display has not turned on for a long time, it should preheat LED display to remove moisture before use, to avoid damage LED because of damp, the specific method: 20% brightness to work for 2h, 40% brightness to work for 2h, 60% brightness to work for 2h, 80% brightness to work for 2h, 100% brightness to work for 2h, by this to gradually increase its brightness.</p>

6.3 Acceptance Request and Method

Table 6-3 Acceptance Request and Method for LED display

Item	Acceptance Request and Method
Brightness of LED Display	Switch LED display to work as full brightness, use light-gun to measure the brightness of LED display within 10 minutes. When measuring its brightness, the light-gun need be vertical to LED display, to adjust the distance of light-gun and LED display, ensure the view window, black area, cover above 16 pixels, adjust focal length, to ensure LED chip being able to clearly view in eyepiece, then measure and record brightness data.
Visual Angle	<p>The one should stand on the angle of 140°, bottom angle 65°to LED display when making measurement, it is requested that LED display should not have obvious the problem of dark block.</p>

Chapter 7 Application Field

It is widely used for various of outdoor application fields, such as the exterior wall of building, Hanging Garden, Government Cultural Plaza, Bus Station, Vertical Advertising aside road, etc.



Zhengzhou University double-sided aluminum screen (220m²)



Jiangyin Gymnasium Aluminum Screen (280m²)

